

MANUAL

SHAPE ARCH
 WIDTH 248cm
 HEIGHT 228cm

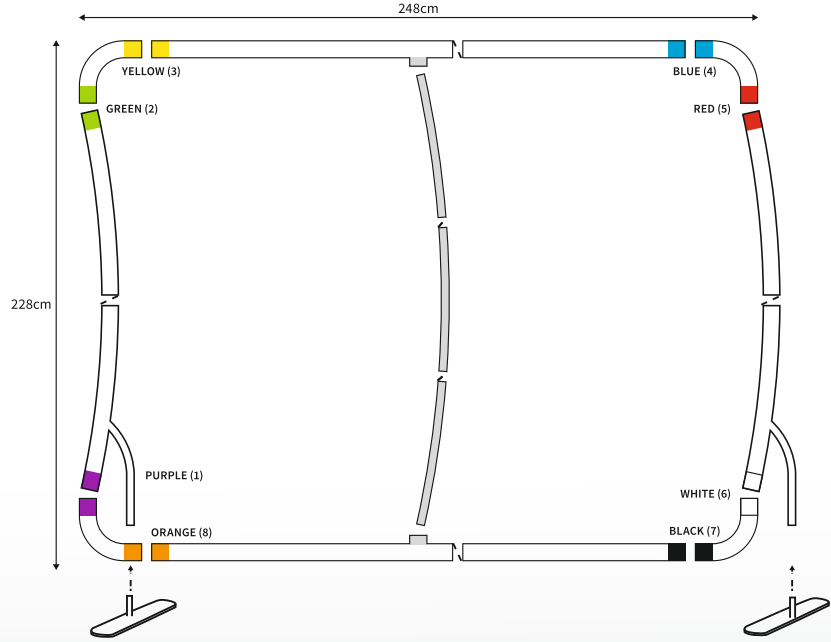

PARTS LIST

	2x	TUBE HORIZONTAL (ø 3cm)
	4x	CORNER
	2x	TUBE VERTICAL (ø 3cm)
	2x	FOOT
	1x	TUBE SUPPORT (ø 2cm)





MANUAL

SHAPE ARCH
 WIDTH 298cm
 HEIGHT 228cm

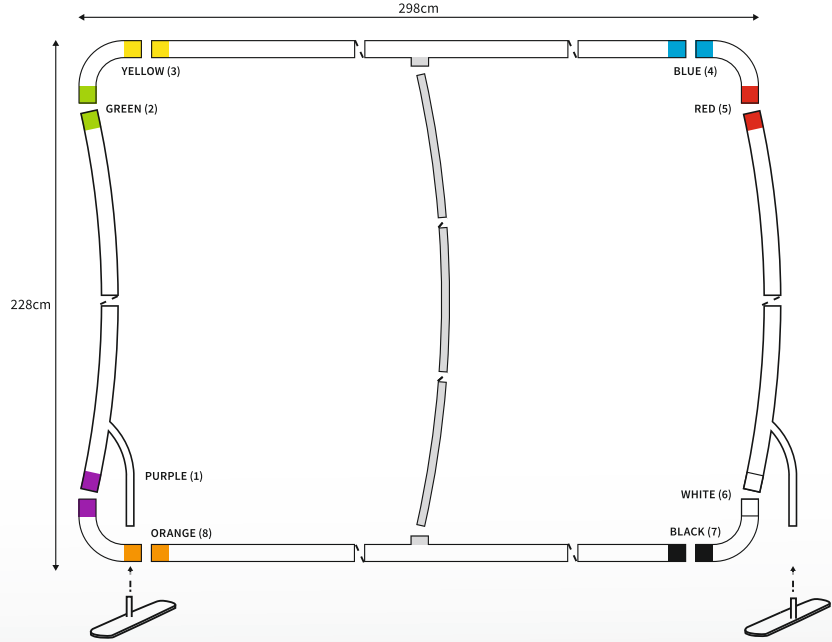

PARTS LIST

	2x	TUBE HORIZONTAL (ø 3cm)
	4x	CORNER
	2x	TUBE VERTICAL (ø 3cm)
	2x	FOOT
	1x	TUBE SUPPORT (ø 2cm)







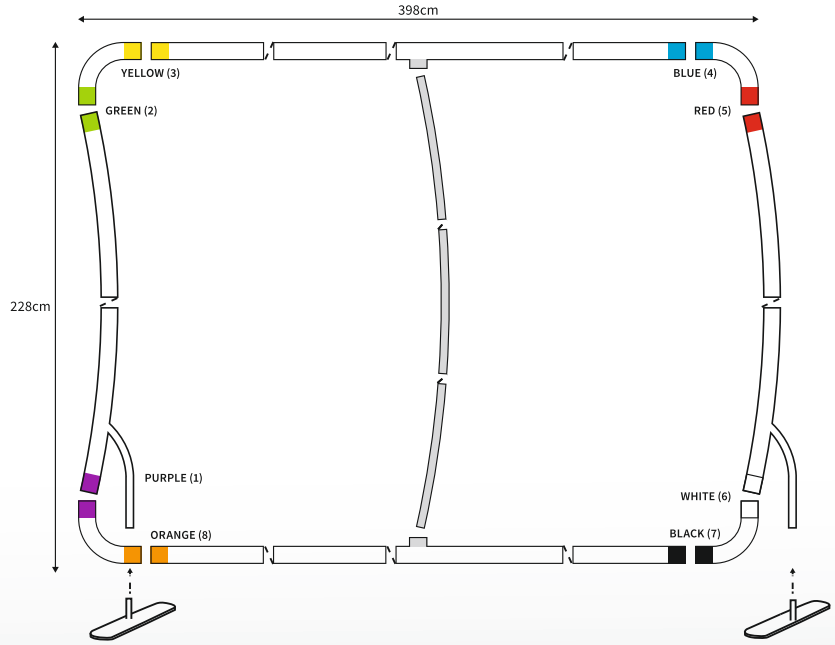

MANUAL

SHAPE ARCH
 WIDTH 398cm
 HEIGHT 228cm



PARTS LIST			
	4x CORNER		2x TUBE HORIZONTAL (ø 3cm)
	2x FOOT		2x TUBE VERTICAL (ø 3cm)
			1x TUBE SUPPORT (ø 2cm)



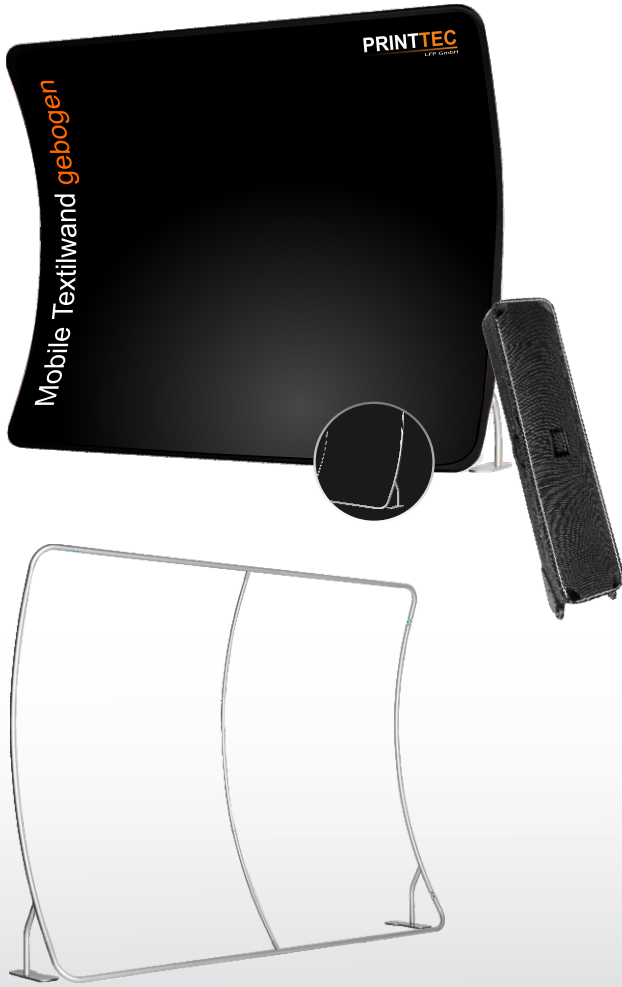



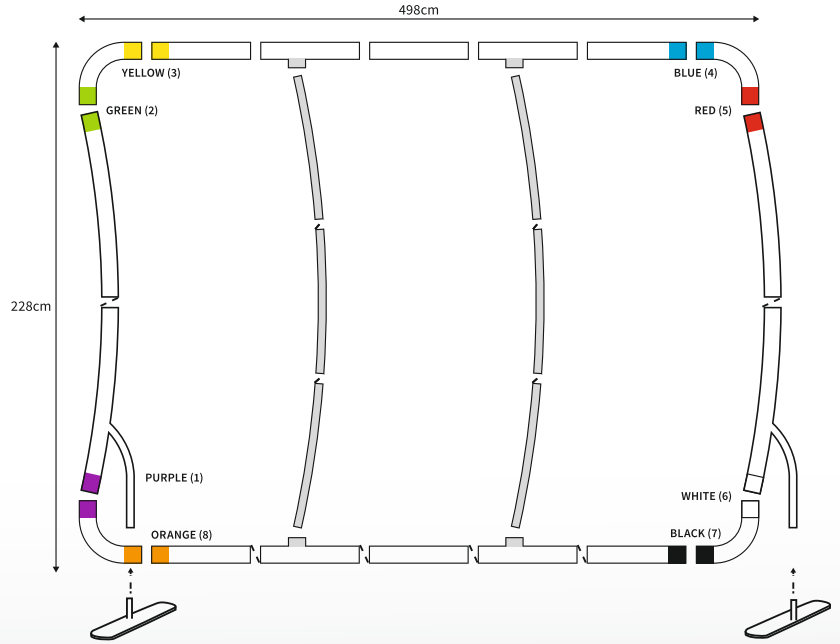

MANUAL

SHAPE ARCH
 WIDTH 498cm
 HEIGHT 228cm



PARTS LIST

	4x	CORNER		2x	TUBE HORIZONTAL (ø 3cm)
	2x	FOOT		2x	TUBE VERTICAL (ø 3cm)
				2x	TUBE SUPPORT (ø 2cm)





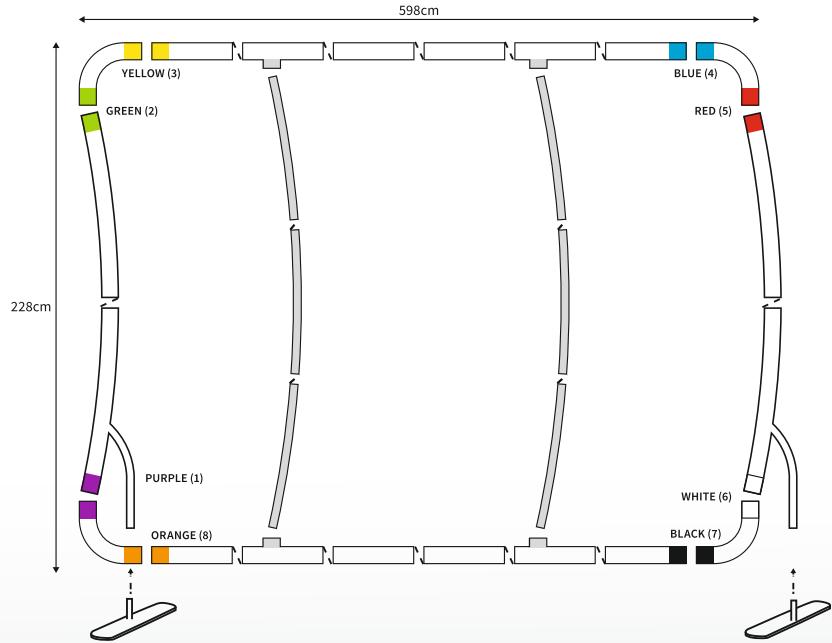

MANUAL

SHAPE ARCH
 WIDTH 598cm
 HEIGHT 228cm



PARTS LIST

	4x	CORNER		2x	TUBE HORIZONTAL (ø 3cm)
	2x	FOOT		2x	TUBE VERTICAL (ø 3cm)
				2x	TUBE SUPPORT (ø 2cm)



Grafische Spezifikationen

Einrichtung der Datei



Die **blaue Linie** ist die Außenlinie der Dokumentenabmessung.



Konfektionierung wird auf die **orangene Linie** gemacht. Dies ist die endgültige netto Abmessung.



Wegen der Konfektionierung sollten wichtiger Text und Abbildungen innerhalb der **grünen Linie** bleiben. Die grüne und blaue Linie sind **7 cm** auseinander platziert.



Anlieferung Datei

- 1: Bitte entfernen Sie alle Angaben der Abmessungen und alle Linien (orange, grün und blau).
- 2: Standard ist die Rückseite der Grafik weiß (ohne Druck).
Wenn Sie die Rückseite der Grafik bedruckt haben möchten, dann fügen Sie bitte das Design als zweite Seite der Datei ein.
- 3: Liefern Sie die Datei in Originalgröße und im PDF-Format an über E-Mail / YouSendit / WeTransfer.

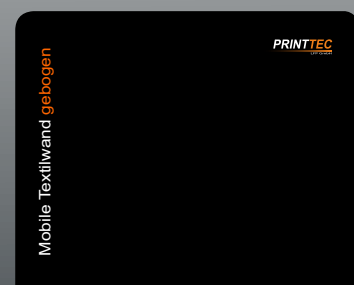
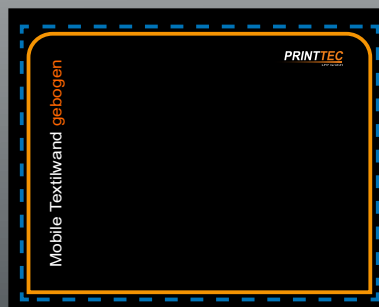
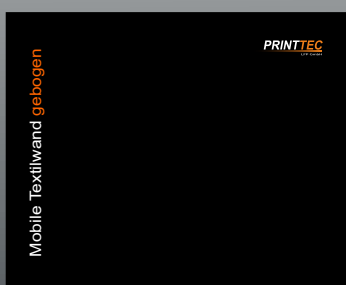



Rahmen

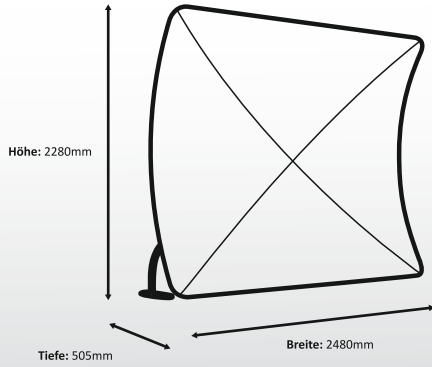

MANUAL

SHAPE ARCH
 WIDTH 248cm
 HEIGHT 228cm

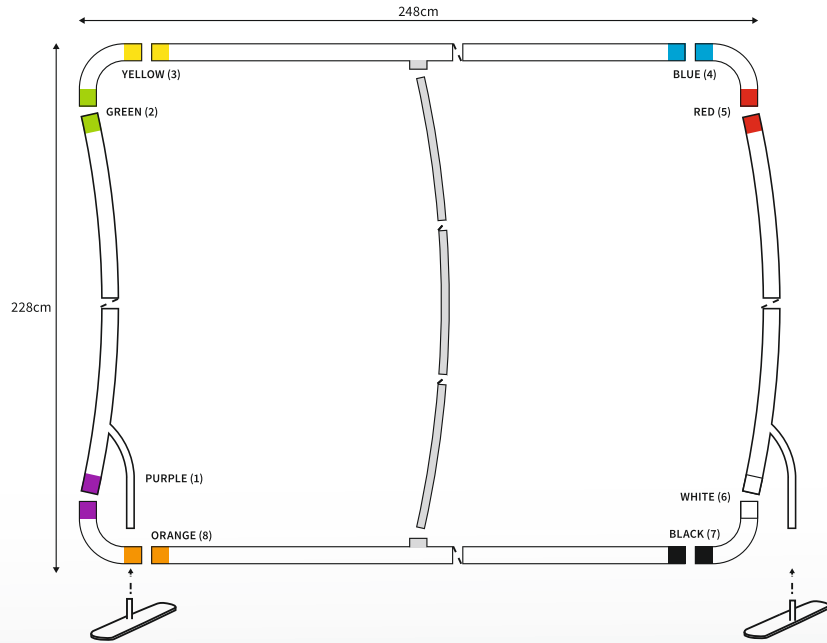

Grafik

Tatsächliche Größe der Grafik: 2480 * 2400 mm (B/H)

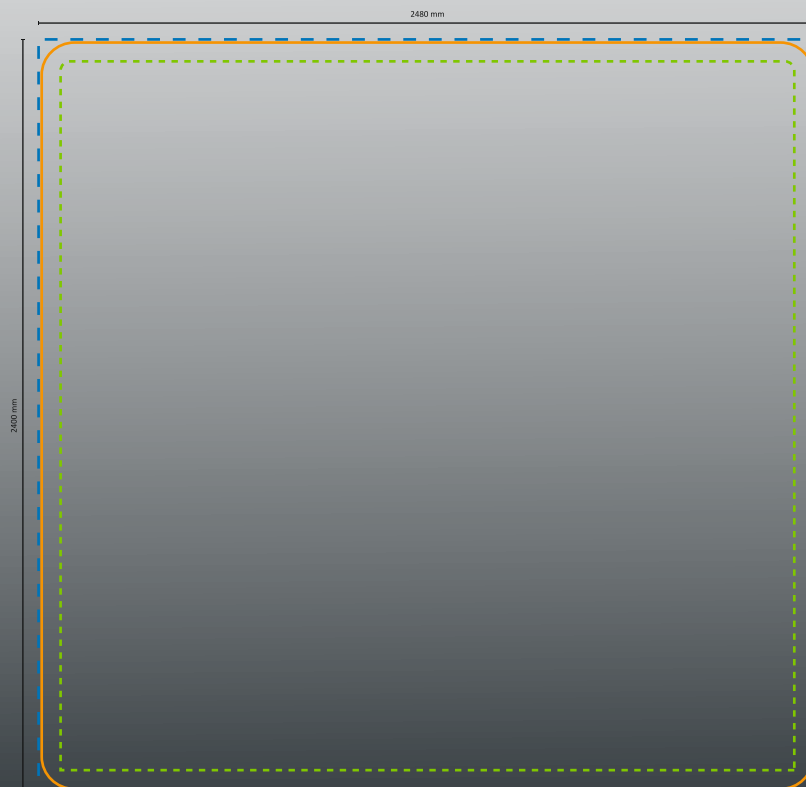



Rahmen

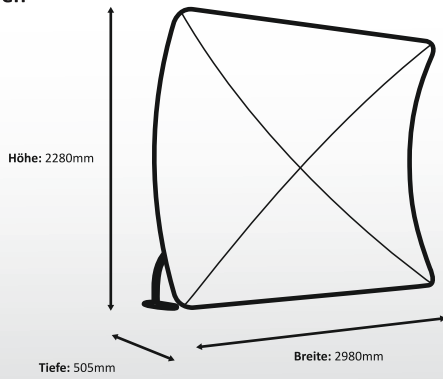

MANUAL

SHAPE ARCH
 WIDTH 298cm
 HEIGHT 228cm

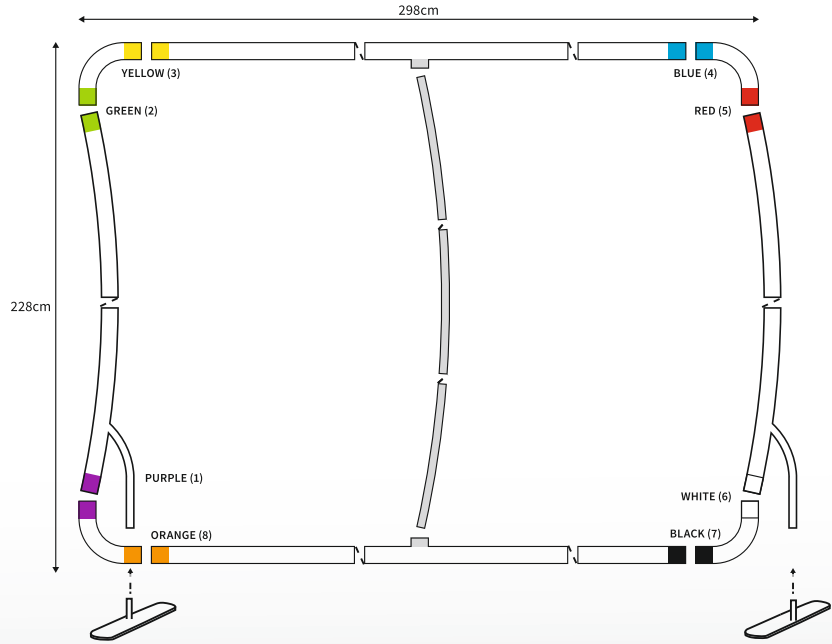

Grafik

Tatsächliche Größe der Grafik: 2980 * 2400 mm (B/H)

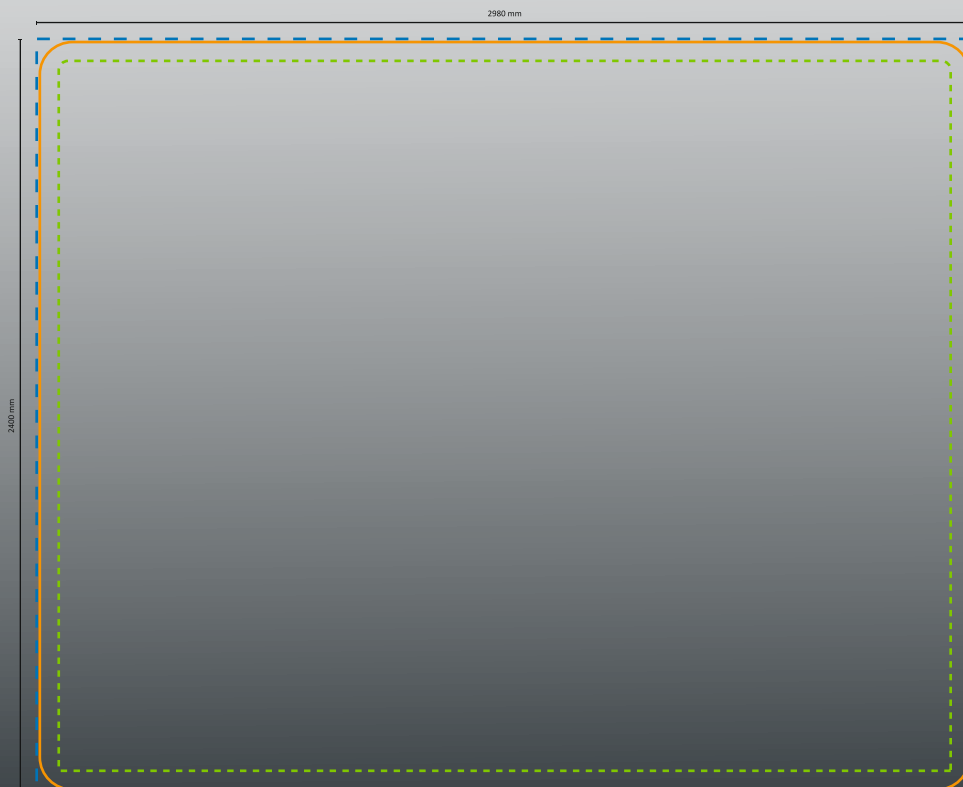



Rahmen

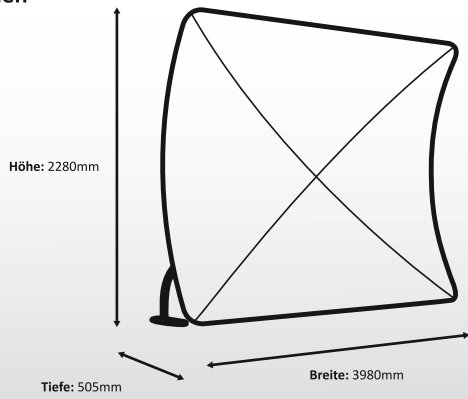

MANUAL

SHAPE ARCH
 WIDTH 398cm
 HEIGHT 228cm

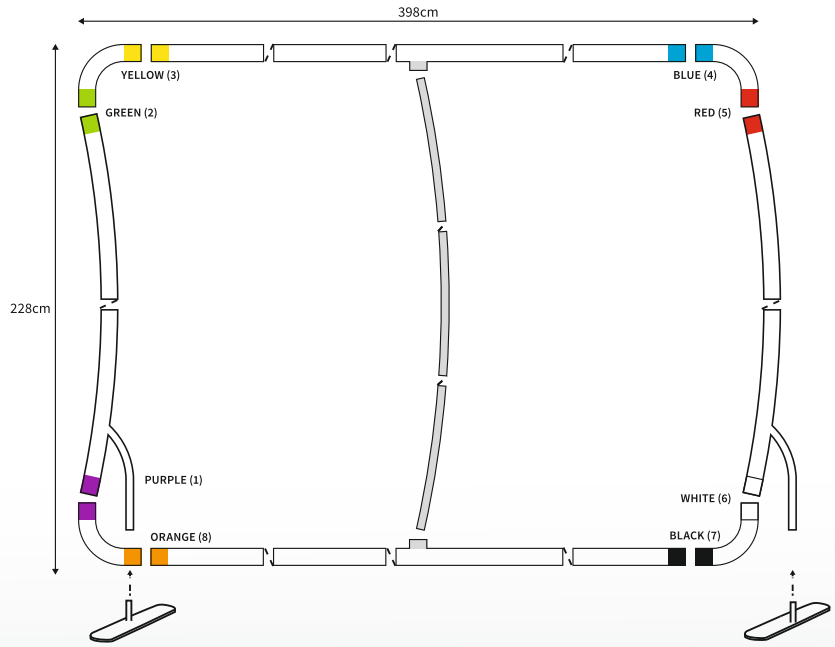

Grafik

Tatsächliche Größe der Grafik: 3980 * 2400 mm (B/H)

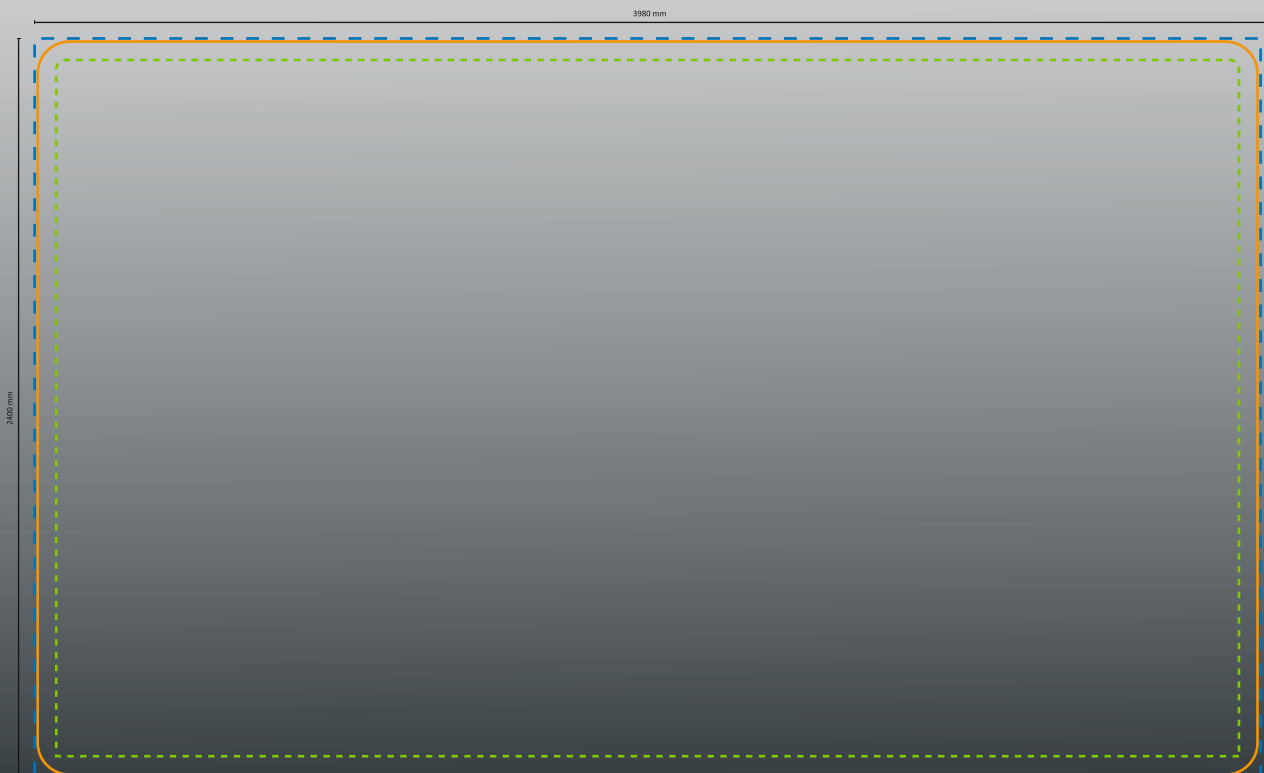



MANUAL

SHAPE ARCH
 WIDTH 498cm
 HEIGHT 228cm

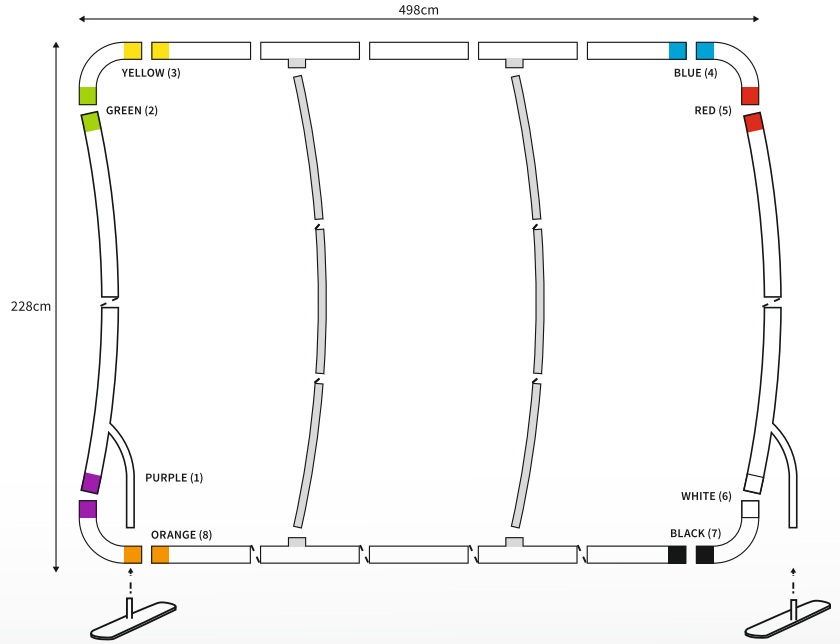

Rahmen

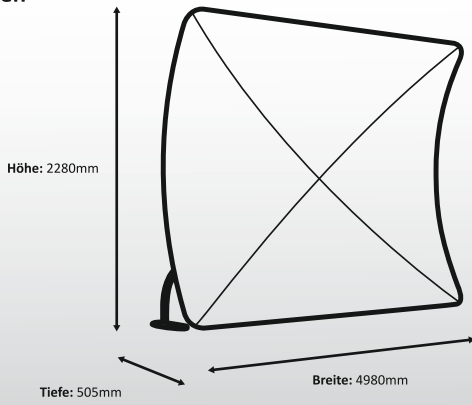

Grafik

Tatsächliche Größe der Grafik: 4980 * 2400 mm (B/H)

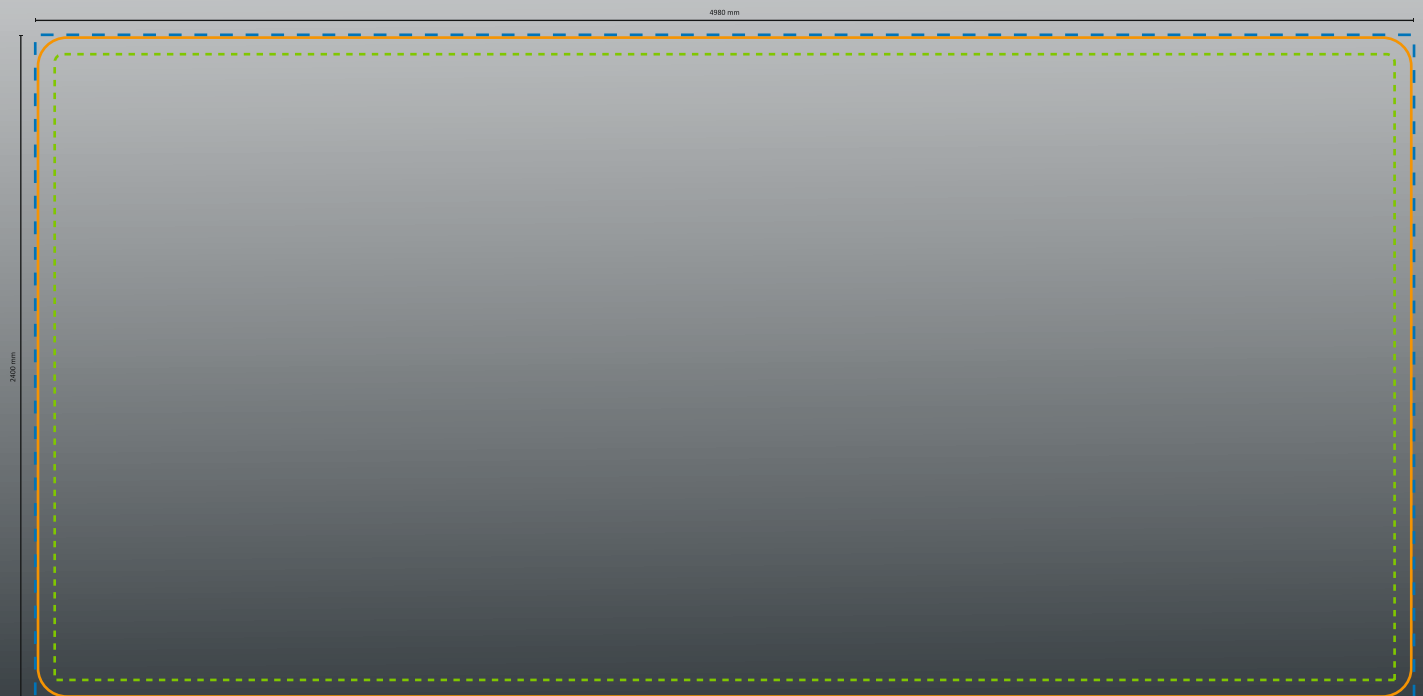



MANUAL

SHAPE ARCH
 WIDTH 598cm
 HEIGHT 228cm

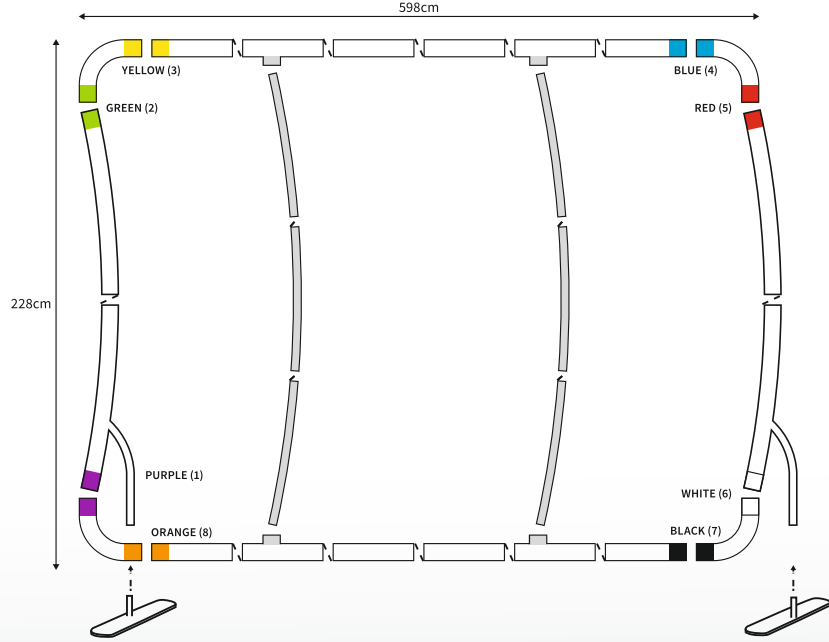

Rahmen

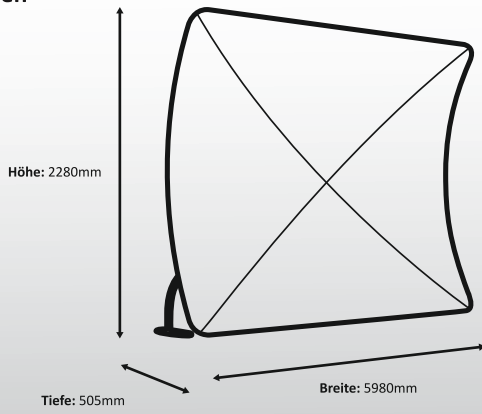

Grafik

Tatsächliche Größe der Grafik: 5980 * 2400 mm (B/H)

