

TECHNICAL GUIDE
Traverse L 3x3m, P768

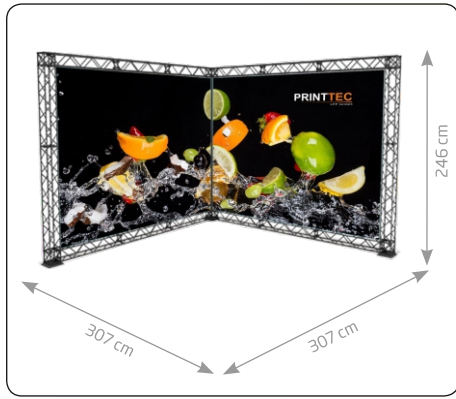

A modular truss system with unlimited possibilities. Made in strong and durable materials: aluminum, steel and composite. Foldable construction - very easy to assemble and disassemble.

Supplied complete with:

- 15 x 90 + 3 x 120 cm Modules,
- 6 x Corner Block,
- 11 x Connector Cross,
- 3 x Regular Base,
- 36 x Top and Bottom Clips,
- 12 x 90 cm Alu Profiles.

Delivered without banner.

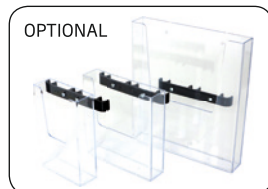
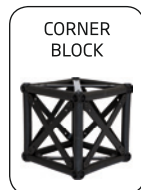
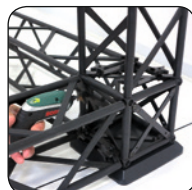

LOWER PART:

- 6 x
- 3 x
- 3 x
- 7 x

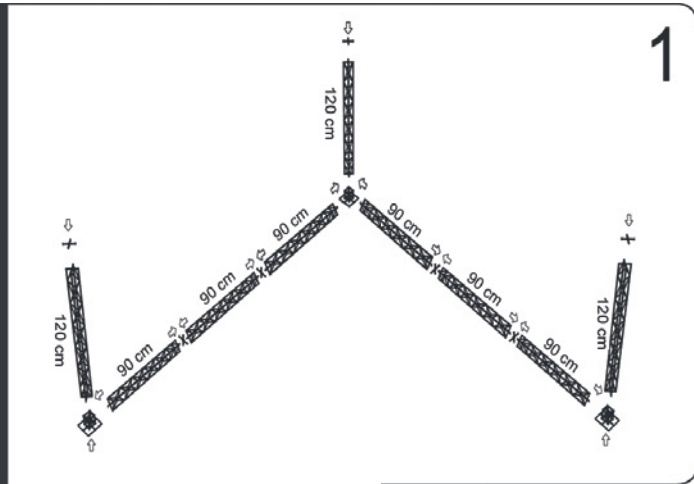

UPPER PART:

- 9 x
- 3 x
- 4 x

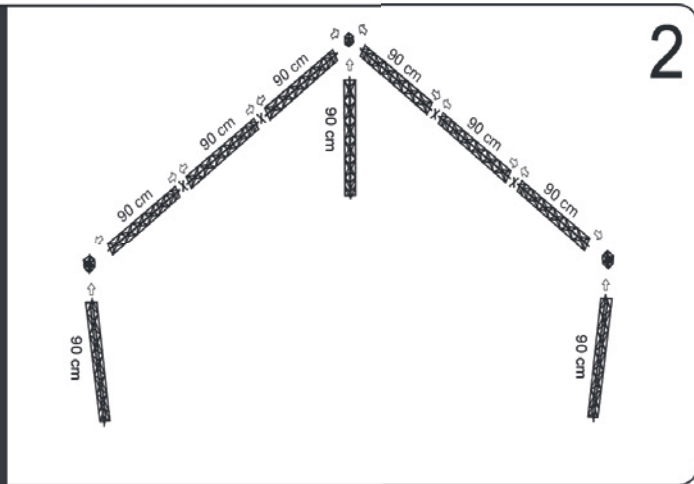

ASSEMBLY:

Install Banners at upper part.

Mount upper part on top of lower part.

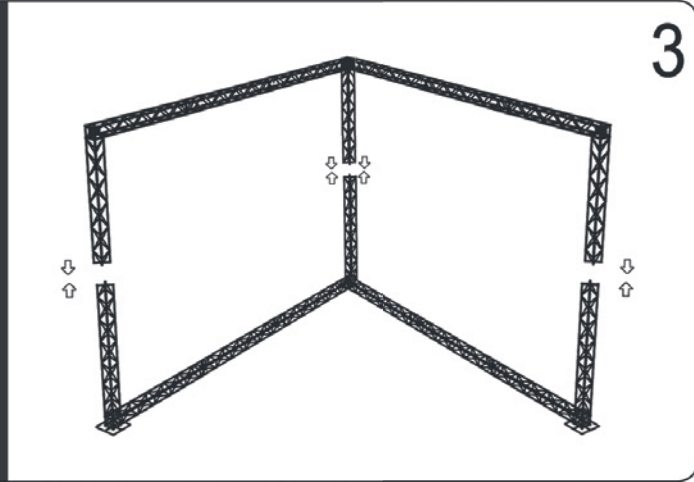

Model	Art.no.	Print size	Colour	Total W x H x D	Package and weight
768	1768	2 pcs. 273 x 212 cm	Black	307 x 246 x 307 cm	2 pcs. cardboard box 52 kg

TECHNICAL GUIDE
Broschürenhalter 3x A4, P803



🇬🇧 Alu Brochure stand with an elegant silver-grey pyramidal base. The brochure pocket itself is made of strong clear acrylic. Available in 2 versions, one with 3 pockets in size A4 and one with 6 pockets in size M65.

🇩🇪 Prospektständer Alu mit elegantem silbergrauem pyramidenförmigen Fuss. Der Ständer ist aus starkem klarem Acryl hergestellt. Wird in 2 Ausführungen geliefert, eine mit 3 Fächer für A4 Prospekte und eine mit 6 Fächer für M65 Prospekte.

🇩🇰 Alu brochurestander med elegant sølvgrå pyramideformet fod. Selve brochureholderen er udført i stærk klar akryl. Leveres i 2 udgaver, en med 3 rum til A4 brochurer og en med 6 rum til M65 brochurer. Indvendig mål på brochureholderens rum er ca. 33 mm.

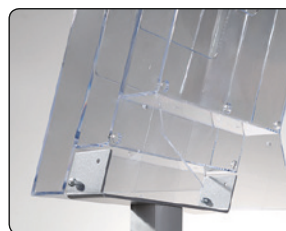
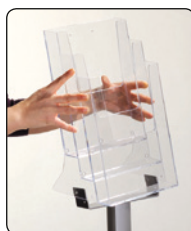

Model	Art.no.	Capacity	Colour	Total W x H	Package size and weight	Pallet size and quantity
803	6485	6 x M65	Silver/transparent	33 x 110 x 25 cm	27 x 52 x 19 + 7 x 87 x 5 cm, 4,9 kg	80 x 120 x 180 cm 48 pcs.
-	6486	3 x A4	-	33 x 120 x 25 cm	27 x 42 x 19 + 7 x 87 x 5 cm, 5,1 kg	84 x 120 x 180 cm 60 pcs.

TECHNICAL GUIDE

Mesetresen Expo, P711



Please note

Max. 0,3mm thickness for printmaterial

 Counter - easy and fast to assemble. Profiles on the frames can easily be unassembled allowing a quick change of the 5 pcs. of 4,7mm PS panels inside. Delivered with a shelf. Black bag is optional.

 Messe Theke aus eloxierte Alurahmen und Zarge sind sehr stabil. Die Füllpaneele können durch leichtes öffnen der Rahmen jederzeit ausgetauscht werden. Wird mit 5 weissen unbedruckten 4,7 mm Paneele und einer Ablage geliefert. Kräftige Tragetasche als Zubehör.

 Messedisk dført i let monterbar panelkonstruktion. De sølv-eloxerede alurammer er nemme at afmontere for ændring af paneler. Leveres med en hylde og 5 hvide 4,7mm PS plader ekskl. print. Taske købes som tilbehør.

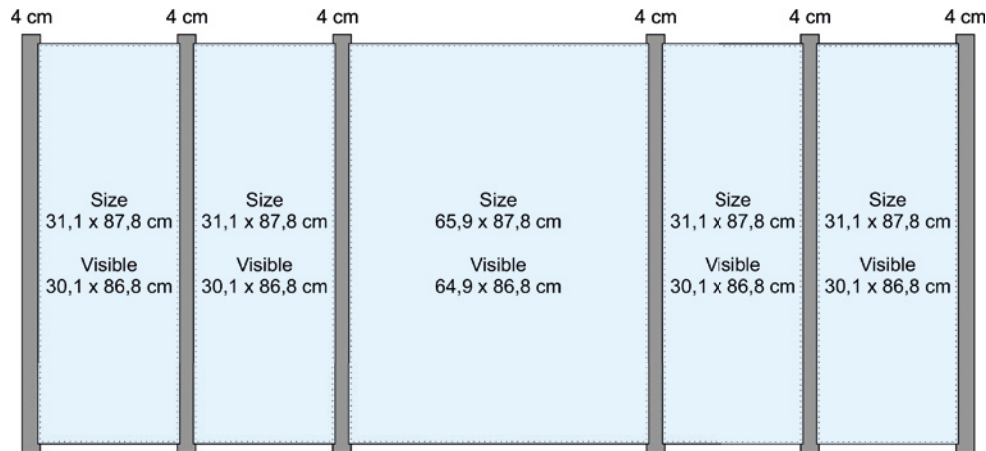
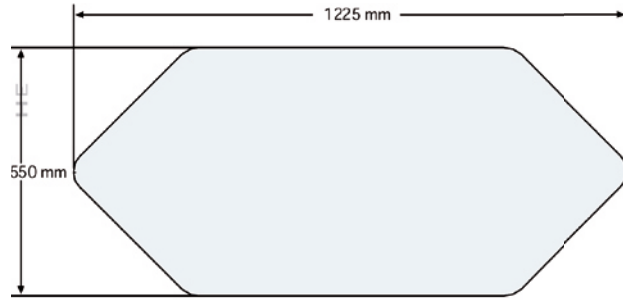

Model	Art.no.	Panels	Colour	Total W x H x D	Package size and weight	Pallet size and quantity
711	4647	65,9 x 87,8 cm + 4 pcs. 31,1 x 87,8 cm	Alu	122,5 x 93 x 55 cm	72 x 128 x 13 cm 22 kg	80 x 130 x 220 cm 12 pcs.
	46470	Bag	Black		3 kg	